

# Identification of horses by hair as trace evidence - case study

---

**Lurie, David**

**Master's thesis / Diplomski rad**

**2024**

*Degree Grantor / Ustanova koja je dodijelila akademski / stručni stupanj:* **University of Zagreb, Faculty of Veterinary Medicine / Sveučilište u Zagrebu, Veterinarski fakultet**

*Permanent link / Trajna poveznica:* <https://um.nsk.hr/um:nbn:hr:178:746280>

*Rights / Prava:* [In copyright / Zaštićeno autorskim pravom.](#)

*Download date / Datum preuzimanja:* **2025-03-16**



*Repository / Repozitorij:*

[Repository of Faculty of Veterinary Medicine -  
Repository of PHD, master's thesis](#)



THE UNIVERSITY OF ZAGREB  
FACULTY OF VETERINARY MEDICINE

UNIVERSITY INTEGRATED UNDERGRADUATE AND GRADUATE STUDY  
VETERINARY MEDICINE

**David Lurie**

**Identification of horses by hair as trace evidence - case study**

Zagreb, 2023

David Lurie

Forensic and State Veterinary Medicine Unit

Head: prof. dr. sc. Severin Krešimir

Mentor: prof. dr. sc. Severin Krešimir

Members of the Committee for the defence of Diploma thesis:

1. Prof. dr. sc. Snježana Kužir
2. Prof. dr. sc. Dean Konjević
3. Prof. dr. sc. Krešimir Severin

This paper consists of 41 pages, 14 figures, 4 tables and 26 references.



## **ACKNOWLEDGEMENTS**

I want to thank my family and friends that supported and always believed in me, also to my friends and colleagues through the years and last and not least my mentor Prof. Severin who was very patient and helpful with every question I had.

## FIGURES

Figure 1.: Hair cuticle scale patterns, scale margin type, and distance between scales in large ruminants (a, b) of buffalo and (c, d) of cattle. Note (yellow). (MADKOUR and ABDELSABOUR-KHALAF et al., 2022).

Figure 2.: Hair cuticle scale patterns, scale margin type, and distance between scales in carnivores (a, b) of cat and (c, d) of dog. Note cortex (yellow). (MADKOUR and ABDELSABOUR-KHALAF et al., 2022).

Figure 3.: Hair cuticle scale patterns, scale margin type, and distance between scales in small ruminants (a, b) of goat and (c, d) of sheep. Note cortex (yellow) (MADKOUR and ABDELSABOUR-KHALAF et al., 2022).

Figure 4.: The developmental process of Hair Ontogeny (COLLABORATOR and COLLABORATOR, 2023).

Figure 5.: Cross section showing the layers of the hair shaft (AHMED et al., 2018).

Figure 4.: Morphology of the hair cuticle scales in different animal species. A. buffalo; B. camel; C. cow; D. horse; E. donkey; F. sheep; G. goat; H. dog; I. cat. Scale bar: 25  $\mu\text{m}$  (AHMED et al., 2018).

Figure 5.: Morphology of the hair medulla in different animal species. A. buffalo; B. camel; C. cow; D. horse; E. donkey; F. sheep; G. goat; H. dog; I. cat. Scale bar: 62.5  $\mu\text{m}$  (AHMED et al., 2018.).

Figure 6.: A map of the scene: A. Horses direction towards the road, B. Car's Direction on the road, 1+2. Breaks marks, 3. Car accident location, 4. Hair and glass located Infront of car.

Figure 7.: A hair sample of the suspected mare (evidence tag 62).

Figure 8.: Animal hair collected on the front of the car at the scene (evidence tag 62).

Figure 9.: A machete wrapped in a white sheet (evidence tag 1022).

Figure 10.: The morpho-metric features of the hairs collected from the suspected mare, evidence tag 62, a) multiple hairs, b) middle part of the hair with visible pith, c) tip of the hair, d) root of the hair, e) broken part of the hair and f) surface of the hair.

Figure 11.: The morpho-metric features of the hairs collected from the car, evidence tag 67, a) multiple hairs with pieces of glass, b) middle part of the hair with visible pith, c) tip of the hair, d) root of the hair and e) surface of the hair.

Figure 14.: Genotyper™ software analysis of PCR amplification products separated on the Applied Biosystems® 310 Genetic Analyzer. Comparison of results at STR loci: ASB17, LEX3, HMS1 and CA425.

## **TABLES**

Table 1.: Morphological characterization of Hair in different species (AHMED et al., 2018).

Table 2.: List of submitted material evidence for forensic analysis.

Table 1.: Result of BLAST alignment correspondence.

Table 4.: Result of allelic distribution on the 17 equine STR loci.

## TABLE OF CONTENTS

1. <b>INTRODUCTION</b> .....	1
2. <b>LITERATURE REVIEW</b> .....	3
2.1. Hair .....	3
2.2. Ontogeny of the Hair .....	5
2.3. Anatomy Of the Mammal Hair .....	7
2.4. Macrostructure and patterns of hairs.....	9
2.5. Microstructure and patterns of Hairs .....	10
2.6. Types of cross-sections .....	16
2.7. DNA analysis for Hair Identification.....	18
3. <b>MATERIAL AND METHODS</b> .....	22
3.1. Findings from the court file .....	22
3.2. Findings and opinion of the expert witnesses on the evidence .....	24
4. <b>DISCUSSION</b> .....	35
5. <b>CONCLUSIONS</b> .....	37
6. <b>REFERENCES</b> .....	39
7. <b>ABSTRACT</b> .....	42
8. <b>SAŽETAK</b> .....	43
9. <b>CURRICULUM VITAE</b> .....	44



## 1. INTRODUCTION

The use of trace evidence in forensic investigations has significantly expanded over the years, encompassing various biological and non-biological materials. Hair as trace evidence has proven to be a valuable tool for species identification, often playing a crucial role in criminal investigations involving animals (BAILEY et al., 2016). This thesis focuses on the identification of horses, through hair as trace evidence, utilizing a comprehensive case study approach to demonstrate the efficacy of this technique.

The research employs a multidisciplinary methodology, combining microscopic analysis, molecular techniques, and statistical models to accurately distinguish horsehair from other similar animal hair samples. Microscopic features such as cuticle patterns, medulla structures, and pigment distribution are analyzed to establish a reliable framework for differentiation (TÓTH, 2017; AHMED et al., 2018).

Incorporating advanced molecular methods, mitochondrial DNA analysis is performed on a subset of samples to supplement the microscopic findings. The genetic markers specific to horse species aid in confirming the morphological identifications and contribute to the establishment of a robust identification protocol. Furthermore, statistical models are deployed, considering the variability in hair characteristics and genetic markers, to provide a quantitative assessment of the identification process's accuracy (PÉREZ et al., 2023).

The case study component of this thesis illustrates the practical application of the identification protocol within real-world forensic scenarios. By showcasing the integration of microscopic, molecular, and statistical approaches, the case study highlights the thesis's contribution to advancing the field of equine forensics.

In conclusion, this thesis underscores the significance of hair as trace evidence for the identification of horses in forensic investigations. The combined use of microscopic analysis, molecular techniques, and statistical models enhances the reliability and accuracy of species identification, thereby aiding law enforcement agencies and judicial systems in equine-related cases. The findings presented herein not only contribute to the scientific understanding of trace

evidence analysis, but also offer practical insights into the realm of animal-related forensic investigations.

## **2. LITERATURE REVIEW**

### **2.1. Hair**

Keratin is the main constituent of mammal hair. The structure of fully formed hairs remains unchanged following the process of keratinization, and their physico-chemical and histological characteristics can be maintained for an extended period, even when exposed to varying environmental conditions (FARAG et al.,2018). The microstructures of the hair, including the arrangement of the cuticle, cortex, and medulla, remain essentially unaltered. They exhibit high resistance to the harsh chemical and thermal conditions of the environment (TÓTH, 2017).

Hair morphology analysis is frequently employed in forensic investigations to ascertain the origin of hairs discovered at crime scenes or in instances of wildlife poaching (DE MARINIS and ASPREA, 2006). The storage and collecting of hair samples are of utmost importance in ensuring precise identification. This process may entail the utilization of hermetically sealed receptacles for sample storage or the application of chemical agents to safeguard against degradation (DE MARINIS and ASPREA, 2006).

Reference collections of animal hairs are commonly maintained by various universities and research groups to facilitate the process of identification. These collections offer a significant resource for conducting comparisons (MADKOUR and ABDELSABOUR-KHALAF, 2022). Reference databases for animal hair identification used in forensic investigations are provided by scanning electron microscopy (SEM) for morphological evaluation of animal hair. (MADKOUR and ABDELSABOUR-KHALAF, 2022).

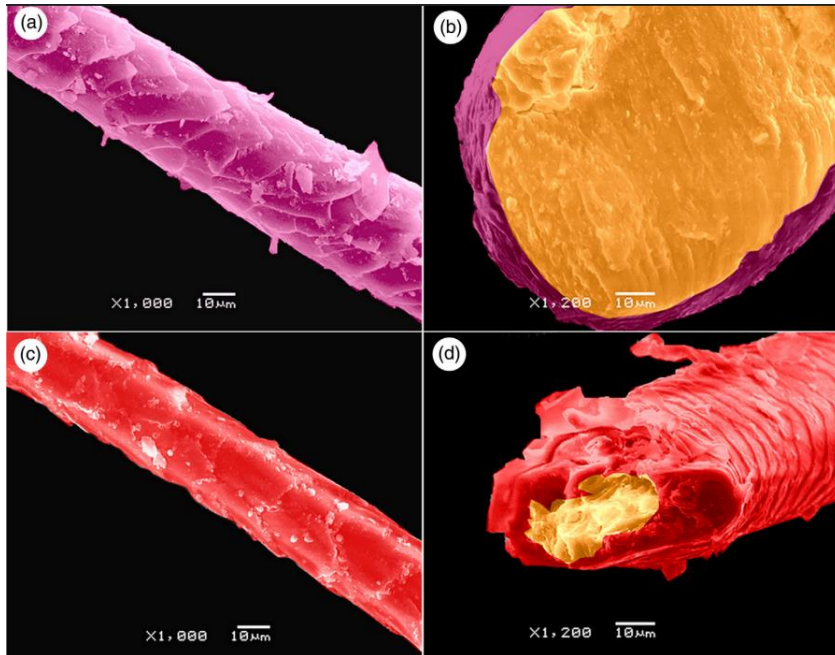

Figure 12.: Hair cuticle scale patterns, scale margin type, and distance between scales in large ruminants (a, b) of buffalo and (c, d) of cattle. Note (yellow). (MADKOUR and ABDELSABOUR-KHALAF et al., 2022).

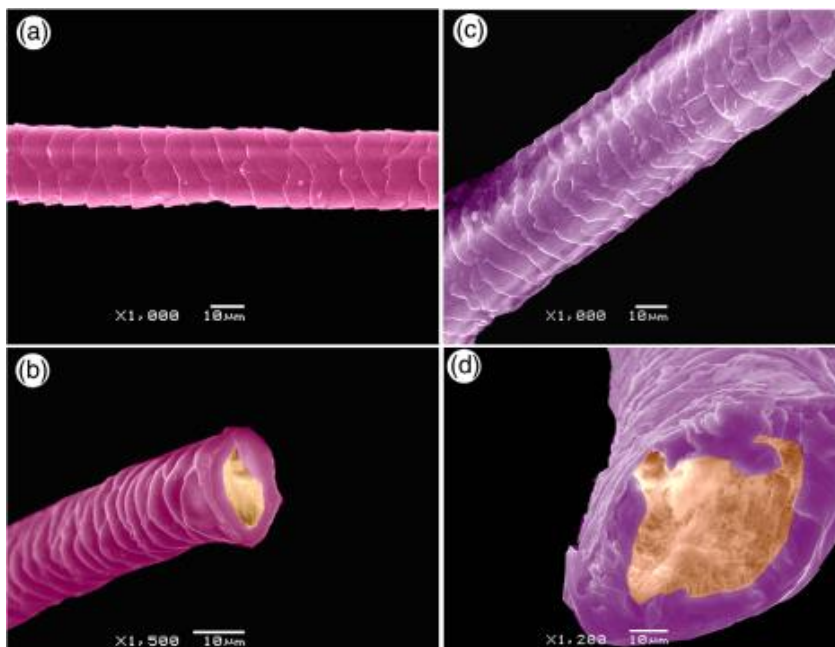

Figure 13.: Hair cuticle scale patterns, scale margin type, and distance between scales in carnivores (a, b) of cat and (c, d) of dog. Note cortex (yellow). (MADKOUR and ABDELSABOUR-KHALAF et al., 2022).

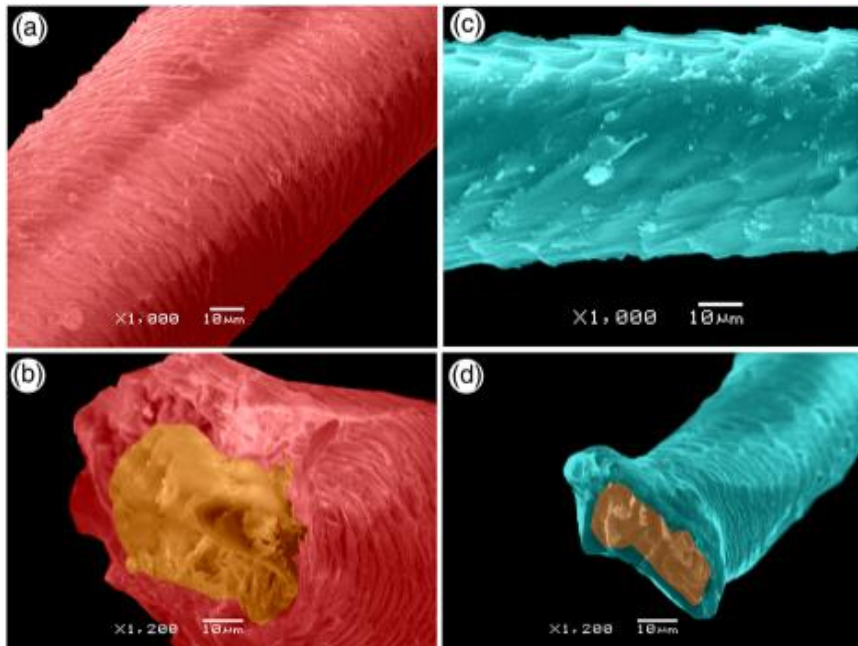

Figure 14.: Hair cuticle scale patterns, scale margin type, and distance between scales in small ruminants (a, b) of goat and (c, d) of sheep. Note cortex (yellow) (MADKOUR and ABDELSABOUR-KHALAF et al., 2022).

## 2.2. Ontogeny of the Hair

The development of hairs with varying structures and functions is influenced by a combination of internal and environmental influences (CHERNOVA et al., 2002).

The sequential order of the three primary developmental stages, namely anagen, katagen, and telogen, is consistent throughout ontogeny. However, the duration and intensity of these phases exhibit variability, influenced by factors such as the age and physical state of the organism, as well as the specific placement of the hairs on its body (PARAKKAL and ALEXANDER, 1972; BANKS et al. 1981; WENNIG et al., 2000).

1. The initial stage in the development of hair is referred to as the anagen phase. The outermost layer of the skin, known as the epidermis, undergoes a process of invagination into the deeper layer called the cutis. This invagination causes the secondary matrix cells to migrate into the

deeper layers, resulting in the formation of a structure known as the bulb (TÓTH., 2017). The rising mitotic activity of the bulb cells and the keratinization begins the longitudinal growth of the scapus. During this process, the keratin microfibrils and amorphous proteins exhibit an increase in both size and number as they approach the body's surface. As the cells become fully saturated with these substances, the keratin pattern becomes visible (TÓTH, 2017).

The distribution of proteins varies across the layers of the hair. Specifically, the cortex layer exhibits a protein ratio of 1:1, but the cuticle and medulla layers contain a significantly higher proportion of amorphous proteins (PARAKKAL and ALEXANDER 1972, BANKS 1981, WENNIG 2000).

2. The subsequent stage, known as the katagen phase, is characterized by regression. The mitotic activity of cells diminishes, leading to the initiation of hair movement towards the skin surface alongside the surrounding cells of the dermis and cutis. Additionally, the processes of nourishment and pigment formation in the hair halt (TÓTH, 2017). The bulb and the hair together exhibit a club-shaped morphology. The secondary germ cells undergo development beneath these hairs. The basal layer of cells undergoes downward invagination, whereas the remaining layers are subject to degradation by lysosomal enzymes (PARAKKAL and ALEXANDER 1972, BANKS 1981, WENNIG 2000).
3. The third phase, known as telogen, is characterized by a period of rest. One of the primary roles of the telogen phase is to secure the hair in position throughout the preceding anagen phase, while also facilitating the regeneration of the subsequent generation of anagen hairs (TÓTH, 2017). The novel formations observed in this phase encompass the club and its surrounding germ. The club is connected to the hair shaft at one extremity and to the germ at the opposite extremity. The club is accountable for securing the hair in its position, while the germ cells are responsible for generating the subsequent generation of anagen hair. The process of shedding or exfoliation occurs when freshly produced hair displaces older hair that is emerging (PARAKKAL and ALEXANDER 1972, BANKS 1981, WENNIG 2000).

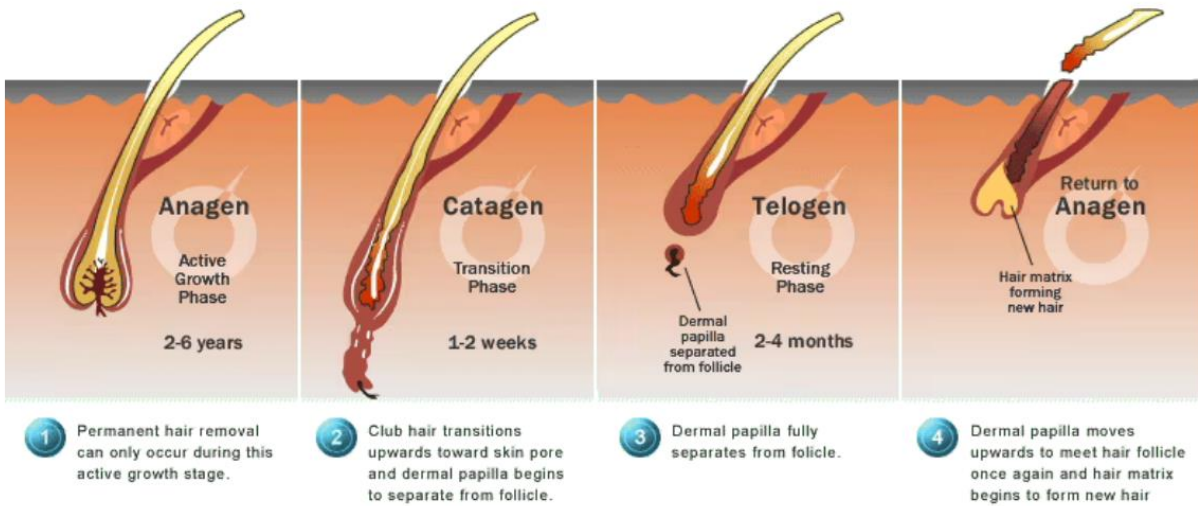

Figure 4.: The developmental process of Hair Ontogeny (COLLABORATOR and COLLABORATOR, 2023).

### 2.3. Anatomy Of the Mammal Hair

By learning the anatomy of hair, we can understand better the science behind the hair identification of the morphological and molecular level. The structure of hair consists of two primary components: the root, which is lodged under the dermis, and the hair shaft or stem, which extends outward from the surface at a specific angle. The hair follicle is a structure resembling a sac that is present inside the integumentary system. The cells are obtained from the epidermis and their primary role is the production of hair (TÓTH, 2017). The bulb, which is situated within the follicle, is characterized by the presence of germinative cells and melanocytes along its lining. The epidermal layer of the hair follicles comprises both the outer and inner layers of the root sheath. The dermal papilla is located within the superficial layer of the dermis, where it functions to supply nutrients and oxygen to the hair bulb by its extension into the dermis. The erector pili muscle is connected to the hair shaft and undergoes contraction in response to cold temperatures, fear, and emotional stimuli, causing the hair to stand upright. Sebaceous glands, which are exclusive to mammals, exhibit an association with the hair follicle and generate oily secretions. These secretions traverse down the hair shaft in an outward direction and disperse across the epidermal surface (TÓTH, 2017).

The structure of hair comprises three main components: an exterior layer known as the cuticle, a middle layer called the cortex, and an inner core referred to as the medulla. The cuticle is produced from the outermost cells of the dermal papilla. It is composed of flattened, strongly keratinized, dead cells devoid of pigments and cellular organs (AHMED et al., 2018). The cortex is formed through the differentiation of cells originating from the medial region of the dermal papilla and the cells comprising the inner root sheath. It holds significant prominence as the primary structural component of the hair. The cortex envelops the entirety of the hair structure, comprising densely interconnected and heavily keratinized, spindle-shaped cells, frequently interconnected by desmosomes. The fusiform cells underwent a transformation throughout their maturity, exhibiting a minor displacement from one another and migrating towards the apex (TÓTH, 2017; BAILEY, 2016). Concurrently, small voids emerged between these cells, which became filled with interstitial liquid in the basal region and air in the upper regions of the hair. The fusiform cells exhibit a high density of macrofibrils, with pigments distributed within the macrofibrils, typically in the form of granules. Occasionally, vestiges of nuclei can also be observed. The cortex can be classified into three distinct regions: the para- (compact), meso- (transitional), and orthocortex (transparent). (TÓTH, 2017). The medulla is formed through the differentiation of keratinocytes situated in the superior region of the dermal papilla. Typically, the medulla exhibits a complex anatomical arrangement. Medullar cells may possess pigments; nevertheless, their dehydration can result in the infiltration of air into their interstitial spaces, so impacting both their coloration and shine (TÓTH, 2017).

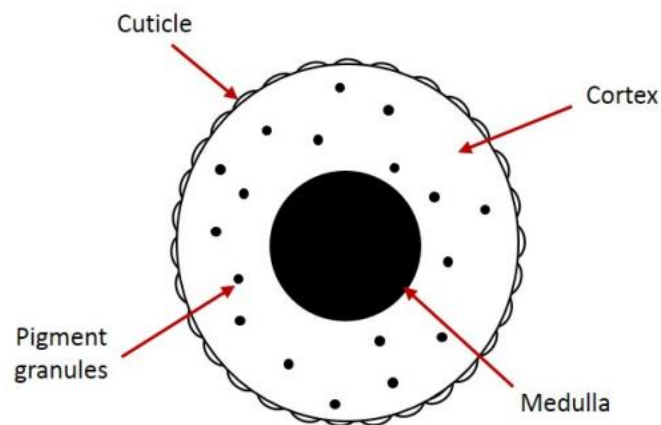

Figure 5.: Cross section showing the layers of the hair shaft (AHMED et al., 2018).



## 2.4. Macrostructure and patterns of hairs

The presence of hairs is a common trait within a taxonomic group, although in most instances, these hairs may be identified at a level higher than the species. The fundamental criteria for identification keys consist of the quantitative characteristics of the macrostructure (TÓTH, 2017).

**1. Bulb** - The morphology of the bulb can exhibit taxon-specific traits, rendering it a valuable tool for identification purposes in such instances. The shape of the hair is subject to small variation because of the maturation phase, and it is infrequently retained on the hair once maturity is complete. There are two primary classifications of bulbs, namely the ball bulb and the knobby bulb (TÓTH, 2017).

**2. Hair (stem)** - The adult hair often exhibits a stem or flag that may be categorized into five distinct portions. Additionally, there are variations of hair that possess a more uniform structure, with a stem of relatively equal width and a consistent microstructure over the full length of the hair (TÓTH, 2017).

a) The basal or basal region is anatomically linked to the bulb and exhibits partial growth towards the epidermis. The shape of the object can exhibit three distinct forms: tubular, characterized by a consistent thickness throughout; bulbous, with a thickened section that forms a bulb in a short span; and bottleneck-shaped, where the stem, initially thin and tubular, rapidly widens towards the distal end.

b) The proximal portion of the stem, also referred to as the shaft, typically exhibits a slender and elongated morphology. It is characterized by a wide range of cuticular patterns, which play a significant role in the process of identification.

c) The transit refers to the segment of the stem when alterations occur in the cuticular and sometimes medullar patterns. This region can exhibit either a progressive or sudden expansion towards the distal end.

- d) The shield, also known as the distal portion, refers to the upper segment of the stem. It is often wider and may occasionally have a flattened shape, extending into the apical region. The medullar patterns exhibited by the shield are varied and possess distinct qualities exclusive to a particular taxonomic group. Consequently, these patterns hold significant value as distinguishing characteristics aiding in the process of identification.
- e) The apical section and tip of the hair correspond to the distal end, where the cuticular patterns often exhibit irregularities, lacking distinct figures. These patterns may appear wavy or sketch-like. Additionally, the medulla is typically absent or fractured in this region, and pigmentation is largely diminished. The precise measurement of the apical portion is not well delineated; however, this segment of the hair exhibits a distinct tapering towards the tip, and the microscopic patterns within it generally exhibit a uniform nature. The telescopic pattern is a consequence of the asymmetrical and alternating layout.

The tip of the object may exhibit several shapes, including gradual tapering, sudden tapering, straight, or gently arched. The tip is commonly divided into various taxa, and this division may be associated with the hard structure of the hair and/or mechanical erosion caused by specific environmental circumstances. The pigmentation of the tip may serve as a diagnostic characteristic (TÓTH, 2017; HICKS, 1977).

## **2.5. Microstructure and patterns of Hairs**

The identification of various mammal species can be facilitated by examining the taxonomic traits found in the patterns of hair layers (cuticle, cortex, and medulla), as well as their composition and sequence. These features possess both quantitative and qualitative attributes which help us identify certain animals' species (BRUNNER and COMAN, 1974). The various sorts of patterns are designated based on geometric and natural configurations.

The primary objective of this categorization was to establish a coherent morphological framework that allows for the clear and unambiguous characterization of higher taxonomic categories based on simple and definitive basic structures (TÓTH, 2017; HICKS, 1977).

In many instances, the examination and interpretation of light microscopic patterns are satisfactory for the purpose of identifying hair samples. However, it is worth noting that the examination of ultrastructure, as facilitated by the scanning electron microscope (SEM), may be indispensable for conducting taxonomic and physiological studies (MADKOUR and ABDELSABOUR-KHALAF, 2022).

### *Cuticula*

The cuticular layers of hair resemble tiles, having overlapping sections that are oriented towards the apex. The hairs can exist as either monolayer or multi-layered structures (SARI and ARPACIK, 2018). Human hairs typically consist of 6-10 layers, but wild boar hairs can have up to 35 cellular layers (BLAZEJ et al. 1989). Cuticular scales can be classified according to their shape, orientation, position, and peripheral characteristics. There are three types of scales: transversal, medial, and longitudinal. Transversal scales are shorter, whereas medial scales are about equal in length and width. The apical margins can display various characteristics such as smoothness, crenation, rippling, or dentation. The spatial configuration of scales might vary as distant, proximate, or adjacent. Hairs found within gelatine exhibit two main types of texture: spiky and smooth, with a translucent appearance. By scrutinizing cuticular scales, one can uncover significant insights, such as evidence of physical harm or patterns that are determined by genetics (TEERINK, 1991; CHERNOVA et al. 2002). The qualitative characteristics of cuticular scales encompass the scale index, the quantity of scales within a particular length and section of hair, and the mean surface area. The main structural characteristics of hair are mainly found in the lower and middle sections, although in certain species, it is crucial to analyze the upper and tip regions. (TÓTH, 2017; HICKS, 1977).

### **Cuticular patterns**

In the study conducted on the difference's characteristics of hair in domestic animals, Horses exhibit an imbricated cuticle pattern and have a crenate/smooth margin type. The margin shape of horses is characterized by irregular waves, and the margin distance is intermediate. On the other hand, donkeys have coronal pattern, and buffaloes have a rippling margin type. Sheep for instance, exhibit an irregular mosaic shape, while goats possess a regular wave margin shape.

Dogs exhibit a Regular petal margin shape and a wide margin distance, whereas cats have a narrower margin distance. These minute differences aid in distinguishing the hair of different animals and identifying their respective species (AHMED et al., 2018).

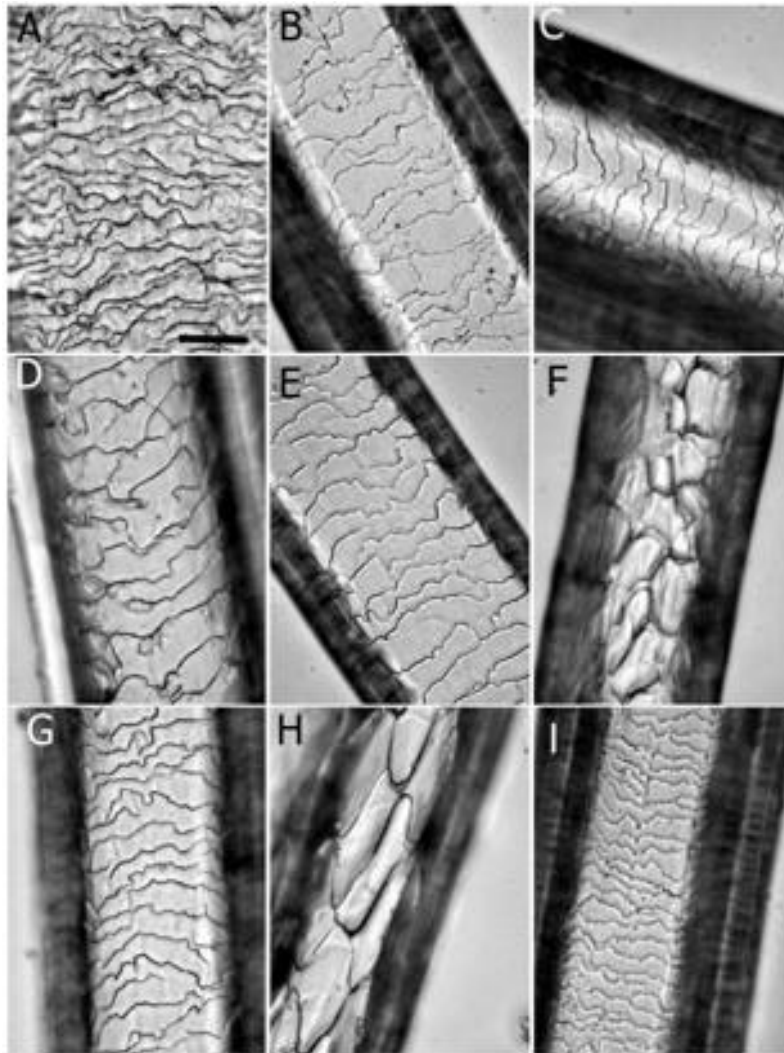

Figure 15.: Morphology of the hair cuticle scales in different animal species. A. buffalo; B. camel; C. cow; D. horse; E. donkey; F. sheep; G. goat; H. dog; I. cat. Scale bar: 25  $\mu\text{m}$  (AHMED et al., 2018).

### *The cortex*

The cortex plays a crucial role in providing structural support to the hair strands. The fundamental configuration of the hair entails a cylindrical shape with uniformly thick walls.

However, this consistent structure is commonly interrupted, since the cortex of the hair may merge with the cuticle in certain regions, while in other areas, it may extend into the medulla (TÓTH, 2017; ALIBARDI, 2012). The correlation between the structure and thickness of the cortex and the natural shape of hairs is evident. In artiodactyla, the cortex tends to be thin, often occupying the entire hair and resulting in either medullaless regions within the hairs or completely medullaless hair types (TÓTH, 2017).

Due to its predominantly uniform composition, the cortex did not display discernible characteristics that may serve as reliable criterion for identification. Conversely, the dimensions and translucency of the cortex, in conjunction with the concentration and color of the pigments accumulating inside the cortex, may serve as significant diagnostic features (TÓTH, 2017; HICKS, 1977).

### ***Medulla***

The medulla, which is a component of the hair, exhibits a diverse array of cellular architecture, size, and organization. The medulla is usually more transparent than the cortex and its dimensions are inversely correlated with the dimensions of the cortex. The edges of the medulla are classified into three categories: straight, fringed, and crested. There is a positive correlation between the thickness of the medulla and the number of cell layers in the medulla, as well as the size of the air sacs (SARI and ARPACIK, 2018).

The thermal insulation capacity is directly proportional to the thickness of the medulla, although the flexibility and strength of the hair are inversely proportional. The size of the medulla's air sacs may vary during the process of shedding, with winter fur having a higher amount of air (HICKS , 1977). In fully developed hairs, the medulla is frequently absent in both the lower and upper sections. Medullary characteristics, such as the medullary index, are valuable for distinguishing different sections of hair. The characteristic patterns of the medulla are commonly visible in regions of greater thickness, such as the transit or shield (TÓTH, 2017).

### **Medullar patterns**

Regarding horses, the medulla is characterized by its continuous nature and a diameter that is less than one-third. The margin of the medulla can either be serrated or notched. Regarding cows, their diameter is greater than half, and their edge is smooth. Sheep, on the other hand, have a fragmented medulla. In the case of goats, the medulla is approximately one-third. The diameter of the donkey's medulla spans nearly the entire shaft, and its margin is smooth. The diameter of the medulla in dogs is approximately half that of the shaft, with smooth margins. In cats, the medulla diameter is greater than half of the shaft, and the margin is somewhat serrated (AHMED et al., 2018).

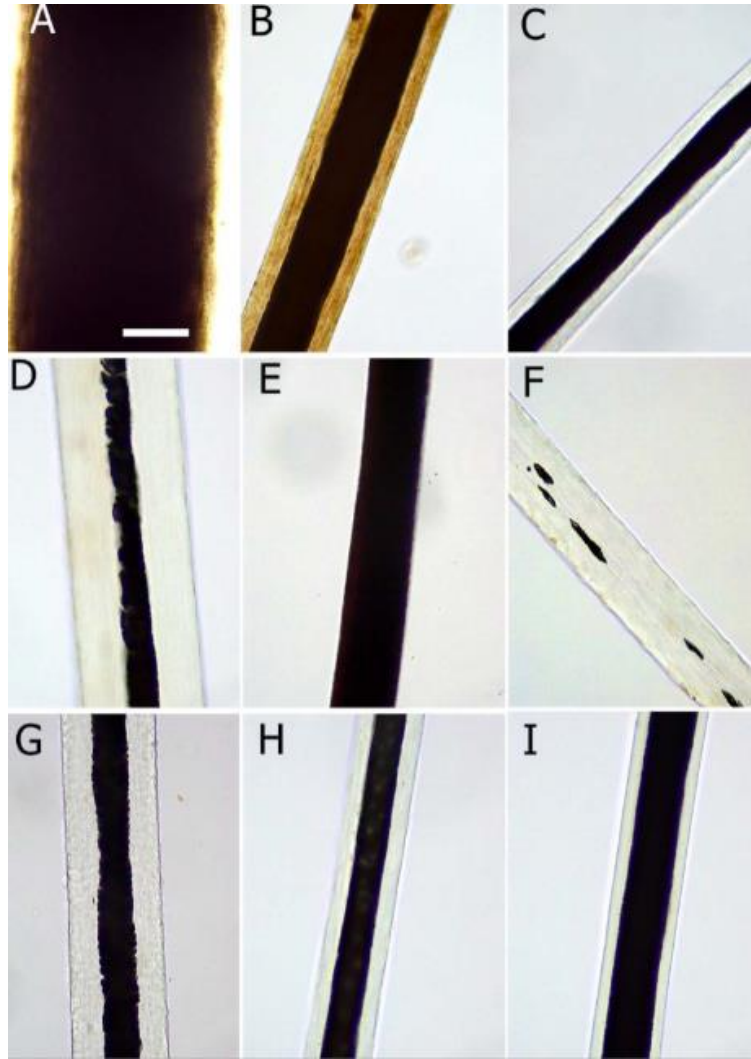

Figure 16.: Morphology of the hair medulla in different animal species. A. buffalo; B. camel; C. cow; D. horse; E. donkey; F. sheep; G. goat; H. dog; I. cat. Scale bar: 62.5  $\mu\text{m}$  (AHMED et al., 2018.).

## 2.6. Types of cross-sections

Hair follicles have distinctive patterns, predominantly located in the middle area and the thickest part. Scanning electron microscopy (SEM) can be utilized to investigate these patterns by analyzing the shapes, sizes, and numbers of grooves and channels. The cross-sectional shapes encompass circular, oval, oblong, convex-concave, biconvex, plano-concave, quadri-concave, triangular, H-shaped, and U-shaped (TÓTH, 2017). Channels refer to the concave indentations found on the outer structure of hair, which typically correspond with the shield or apical region. Channels can extend down the entire length of the hair or be arranged in parallel. The interior surface of channels commonly exhibits a clear lamellate arrangement, which can be analyzed using scanning electron microscopy (SEM). This process made the tested animal's hair cuticle scale patterns and cuticle margin type clearer (TÓTH, 2017; MADKOUR and ABDELSABOUR-KHALAF, 2022).

A study conducted in Egypt has developed an initial reference database for comparing the physical structure of hair among different kinds of domestic animals. The study examined the hair cuticle scales, margin type, form, and scale spacing in all animals. The organization of cuticle scales was determined to be imbricate, apart from donkeys, who had coronal scales. The creatures were classified according to criteria such as scale margin type, shape, and distance. The bovine specimens exhibited undulating edges of the cuticle that were closely positioned and had a form like two chevrons (AHMED et al., 2018). The sheep exhibited well-defined edges, a non-uniform mosaic pattern, and significant gaps between scales. The canines had consistent scale boundaries with a symmetrical form. The feline specimens exhibited crenate scale boundaries that were irregular in shape and positioned tightly together. Horses and camels displayed undulating uneven patterns with moderate intervals. The boundaries of cows exhibited crenations with evenly spaced intervals, maintaining a continuous undulating shape. The study also analyzed the hair medulla and pigmentation to identify domestic animals. Except for sheep, all animals displayed a persistent form of medulla. In dogs, the medulla occupied roughly one-third of the hair shaft and exhibited a smooth contour. Hair shaft pigmentation was absent in all animals, except for camel and buffalo (AHMED et al., 2018).



Table 1.: Morphological characterization of Hair in different species (AHMED et al., 2018).

Species	Cuticle scales				Medulla			Pigmentation
	Pattern	Margin type	Margin shape	Margin distance	Type	Diameter	Margin	
<b>Buffalo</b>	Imbricated	Rippled	Double chevron	Close	Continuous	Almost entire shaft	Smooth	Granules and streak-like pigments
<b>Camel</b>	Imbricate	Crenate	Irregular wave	Intermediate	Continuous	More than 1/2	Smooth	Granules and streak-like pigments
<b>Cow</b>	Imbricate	Crenate	Regular wave	Intermediate	Continuous	More than 1/2	Smooth	No pigmentation
<b>Horse</b>	<b>Imbricate</b>	<b>Crenate/ smooth</b>	<b>Irregular wave</b>	<b>Intermediate</b>	<b>Continuous</b>	<b>Less than 1/3</b>	<b>Serrated or notched</b>	<b>No pigmentation</b>
<b>Donkey</b>	Coronal	Crenate	Regular wave	Intermediate	Continuous	Almost entire shaft	Smooth	No pigmentation
<b>Sheep</b>	Imbricate	Smooth	Irregular mosaic	Wide	Fragmental	-	-	No pigmentation
<b>Goat</b>	Imbricate	Crenate	Regular wave	Intermediate	Continuous	About 1/3	Serrated	No pigmentation
<b>Dog</b>	Imbricate	Smooth	Regular petal	Wide	Continuous	About 1/2	Smooth	No pigmentation
<b>Cat</b>	Imbricate	Crenate	Irregular wave	Close	Continuous	More than 1/2	Slightly serrated	No pigmentation

## **2.7. DNA analysis for Hair Identification**

The domestication of horses by humans commenced approximately 4000 years BCE, leading to the development of over 300 distinct horse breeds through the process of selective breeding (PÈREZ et al., 2023). These breeds encompass a collection of equines that possess traits that are reliably passed down to their progeny, including physical structure, coat color, performance aptitude, and temperament. Breeds have undergone evolutionary changes because of the imperative need for them to fulfill specific tasks, initially related to warfare, agriculture, and industry, and currently primarily associated with recreational and equestrian activities (PÈREZ et al., 2023). There has been an increase in the occurrence of forensically significant incidents involving horses, such as doping control, identity forgery, and horse theft and due to that the usage of DNA analysis has increased as well (VAN DE GOOR & VAN HAERINGEN, 2007; CHEN et al., 2010).

The majority of DNA is in the nucleus of cells, specifically in the form of nuclear DNA, which is organized into pairs of chromosomes. Nevertheless, a minor fraction of the DNA complement is contained within the mitochondria, which is inherited in a distinct manner and is handled differently in forensic scenarios. Forensic scientists find only 0.5% of the DNA code relevant, while the remaining 99.5% is identical for all individuals (RUDIN and INMAN, 2001).

This aspect exhibits significant variation among individuals and is seen in characteristics such as eye color, hair color, and blood type. Minor genetic variants enable the distinction between individuals (BUCKLETON et al., 2018). Offspring receive 50% of their genetic material from their father and 50% from their mother, resulting in a complete set of genes. Minor genetic variants enable the distinction between individuals. DNA STR profiling mostly utilizes intronic regions, which are non-coding portions located between protein-coding regions of DNA. Eukaryotes possess introns, which emerged in the later stages of evolution. These introns tend to include polymorphism areas, enabling the coexistence of diverse forms within populations (BUCKLETON et al., 2018). This information holds significant importance in the process of verifying the identity of an animal, resolving issues related to paternity, or conducting investigations pertaining to theft or fraud.

The utilization of DNA analysis on hair samples proves to be highly advantageous in various scenarios, including the identification of missing or pilfered animals, verification of parentage for selective breeding objectives, and the resolution of legal conflicts pertaining to animal possession. It is imperative to acknowledge that the efficacy of DNA analysis is contingent upon the caliber and soundness of the gathered samples, alongside the precision of the laboratory methodologies employed (VAN DE GOOR et al., 2011).

The technology for analyzing short tandem repeats has evolved to include the utilization of polymerase chain reaction (PCR) on specific STR loci. It facilitates the exponential amplification of minuscule quantities of DNA (BUCKLETON et al., 2018). The resolution of tiny fragments was significantly enhanced with the use of polyacrylamide gel electrophoresis, surpassing earlier methodologies. Therefore, the distinction between STR alleles that vary by 1 repeat was enough to clearly determine genotypes. Smaller alleles were also preferable for the PCR reaction due to the increased efficiency of amplifying low molecular weight DNA fragments. PCR entails multiple rounds of replication. Every cycle has the capacity to increase the quantity of DNA by approximately two-fold. The implementation of PCR-based STR analysis was the primary breakthrough that broadened the applicability of DNA profiling (BUCKLETON et al., 2018).

Due to the extensive integration of horses within human culture, the examination of equine DNA has gained significance in the field of forensic investigation. Nevertheless, the comprehensive characterization of the information content of horse Short Tandem Repeat (STR) loci, which are frequently employed for identification or paternity testing purposes, remains incomplete (VAN DE GOOR et al., 2011).

Modern molecular biology techniques provide rapid, precise, and cost-effective approaches for animal genotyping. Applied Biosystems' Markers product line is specifically tailored for paternity testing, pedigree verification, and criminal case identification. The Horse Genotyping Kit is a significant tool for the horse breeding community, facilitating the identification of genetic traits, and distinguishing between different horse breeds (DIMSOSKI et al., 2003).

A study conducted on the population of Colombian Creole Horses using STR markers to perform filiation tests and equestrian certification. Genomic DNA was isolated from blood, saliva,

and hair samples, and polymerase chain reaction (PCR) amplification was carried out using the Equine Genotypes panel 1.1 kit. The genotypes were ascertained through the utilization of capillary electrophoresis, while the GENEPOP software was employed to compute the frequencies of alleles and genotypes. The panel consists of nine loci endorsed by the International Society for Animal Genetics (ISAG) plus an additional eight loci often employed for horse parentage testing and identification. The chemicals and techniques employed in the panel have been optimized to guarantee consistent peak sizes. The suitability of PCR and electrophoresis settings is determined based on the fluorescence intensities of the Equine Genotypes Control DNA001 alleles (PÈREZ et al., 2023).

The usage of STR's was observed also at the study made on a Population of 17 equine STR for forensic and phylogenetic analysis, The animal breeding industry primarily utilizes equine short tandem repeat (STR) loci for the purpose of parentage verification.

The International Society for Animal Genetics presently acknowledges nine short tandem repeat (STR) loci for regular application in horse kinship analysis. These loci, namely AHT4, AHT5, ASB2, HMS3, HMS6, HTG4, HTG7, HTG10, and VHL20, have been confirmed by several inter-laboratory comparison studies. Starting on January 1, 2011, three specific STR loci, namely ASB17, ASB23, and HMS2, will be included in this collection. The commercial kit from Finnzymes Diagnostics in Espoo, Finland includes the entire set of 17 short tandem repeats (STRs) and is commonly used by providers of horse genotyping. The Food and Agriculture Organization (FAO) recommends the use of all Short Tandem Repeats (STRs) as markers for diversification research, except for HMS1 and the X-chromosomal LEX3.

The efficacy of the 17 equine short tandem repeats (STRs) was examined in the study using a data set consisting of 8641 animals from 35 populations. Marker statistics such as power of exclusion (PE), polymorphic information content (PIC), expected heterozygosity (HE), observed heterozygosity (HO), and probability of identity (PID) were analyzed to determine the effectiveness of these STRs. Additionally, they investigated the dependability of individual assignment tests in accurately determining the breeds of origin for unidentified samples. In conclusion, we can see the evidence of the phylogenetic signal exhibited by the 17 equine short

tandem repeats (STRs), which indicate the presence of distinct population clusters sharing a shared genetic ancestry.

The Friesian, Groninger, Dutch draft horse, and two populations of Dutch Warmblood horses have their origins in the Netherlands. Multiple populations recorded in various studbooks represent the Shetland, Warmblood, and Welsh breeds. Genomic DNA extraction was performed using standard protocols.

Hair root samples were processed by lysing roughly eight hair follicles in a PCR tube using 6 units of proteinase K, following the established methodology. The process of isolating DNA from semen was conducted using the Pure gene DNA isolation kit (VAN DE GOOR et al., 2011).

The loci were genotyped utilizing the Equine Genotypes™ Panel 1.1, manufactured by Finnzymes Diagnostics. The commercial kit was utilized in accordance with the directions provided by the manufacturer. The alleles were detected and classified based on their anticipated fragment length, utilizing predetermined allelic bins with a constant size of 1 base pair (VAN DE GOOR et al., 2011).

### **3. MATERIAL AND METHODS**

#### **3.1. Findings from the court file**

A car driven by M.K was found at the scene of a traffic accident. The accident occurred on October 10<sup>th</sup> at 5.15 am. The driver stated that she was driving through the Skakavac settlement from Sjenicak lasinjo in the direction of Popovic Brdo. She had a passenger in the front seat of her car whom she had picked up in Skakacav. As they were driving through the settlement, two horses appeared on the road to the right of the car. The larger horse of the two was black with a grey chest. The smaller horse was an orange-yellow color. The driver admitted colliding with the largest horse, after which both horses moved away from the accident site.

By the time the criminal investigation team arrived, both horses had left the scene, the car was immobile in the position it had stopped at the point of impact. The investigating team noted the car's registration and interviewed the driver about the circumstances of the accident. These findings were recorded in the official report. Hair traces were removed from the car, their color and appearance suggesting some form of animal hair. In this case, it was hair from the horse that the driver admitted to hitting.

Once the factual evidence had been gathered the investigating team moved their focus to finding the owner of the horses. On October 24<sup>th</sup>, the owner was identified as D.K. contacted the local veterinary practice when she discovered her horse's injuries. The mare had a large open wound located behind the left front leg, where the leg meets the chest. The skin tear was about 30 cm in length in the shape of the letter u and a piece of fatty tissue was hanging from the skin. The horse was anaesthetized, and the wound closed surgically with around 30 stitches. The mare was treated with a course of antibiotics. The mare's foal had a wound on the inside of the front right leg near the hoof. This was washed and cleaned. Based on the injuries presented the veterinarian could not confirm with certainty that the injuries were a result of a traffic accident.

The owner claimed that her horses were kept in an electrified fenced area near the family home. On October 12<sup>th</sup> she had noticed that her horses were wounded but believed the wounds to be caused by a machete found by her neighbor nearby. She claimed to have no knowledge of the traffic accident which she later heard about from a third party. She did not believe her horses had caused the accident and purported her alternative claim that the animals had been injured by the

machete. The investigators proceeded with a detailed expert examination of evidence collected at the scene of the traffic accident and compared this with hair samples taken from both horses and information retrieved from the microchip of the horse. The machete was also forensically examined. This meant that the investigators could determine by DNA conclusively the truth of the situation.

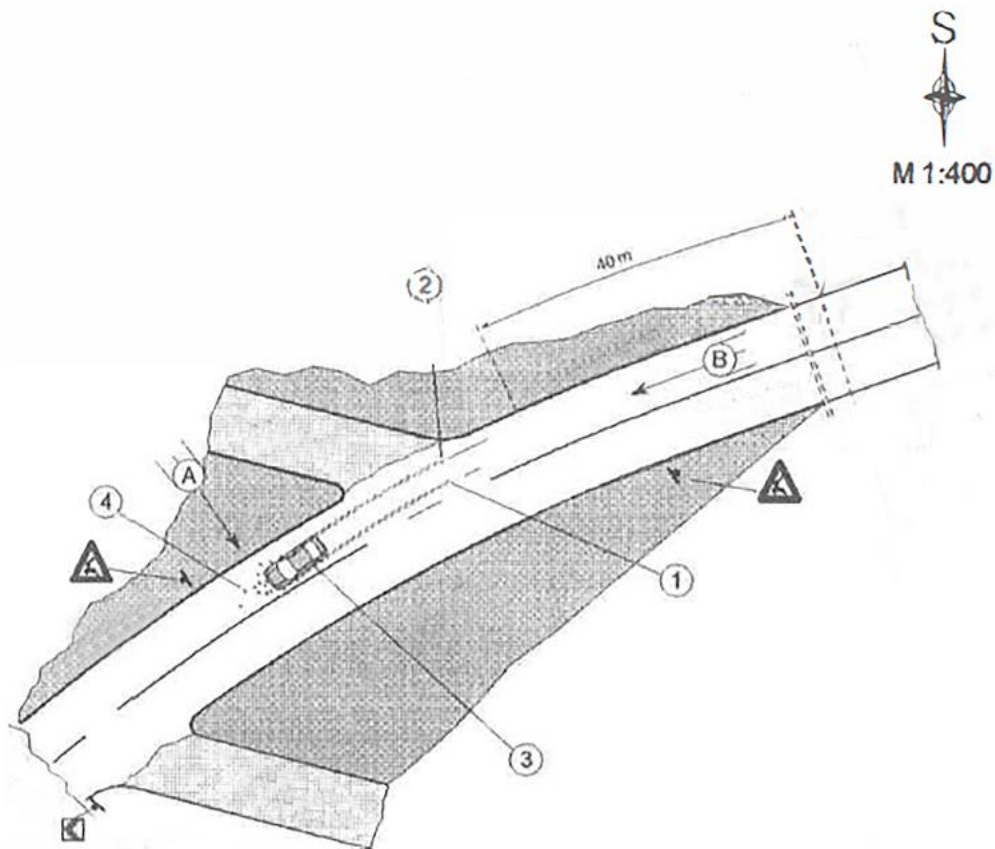

Figure 17.: A map of the scene: A. Horses direction towards the road, B. Car's Direction on the road, 1+2. Breaks marks, 3. Car accident location, 4. Hair and glass located Infront of car.

### 3.2. Findings and opinion of the expert witnesses on the evidence

Table 2.: List of submitted material evidence for forensic analysis.

ID of submitted sample	ID LAB	Description if the delivered material
<b>67</b>	1K	Animal hair found on the front of the car.
<b>62</b>	2K	Hair sample of the suspected mare.
<b>1022</b>	3K	A machete wrapped in a white sheet.

Table 2 provides the comprehensive list of material evidence that has been submitted for forensic analysis. There were two instances of biological hair evidence and one instance of physical evidence, which was a machete that potentially included biological evidence of the suspect's mare's blood. The samples were obtained using aseptic collection, employing gloves, plastic bags, and other conventional sterile techniques to ensure the samples remained uncontaminated.

At the scene of the traffic accident, **evidence tag 67** was used to gather animal hair found on the front of the car. In addition, a hair sample was collected from the suspected mare (**evidence tag 62**) belonging to a known owner, which had a microchip number.

In order to conclusively determine the origin of the given evidence, a two-pronged method was employed, which included examining the physical features of biological materials and utilizing the molecular methodology of DNA analysis. The aim was to ascertain the species' source and contrast the unique DNA profiles of ungulates.





Figure 18.: A hair sample of the suspected mare (evidence tag 62).

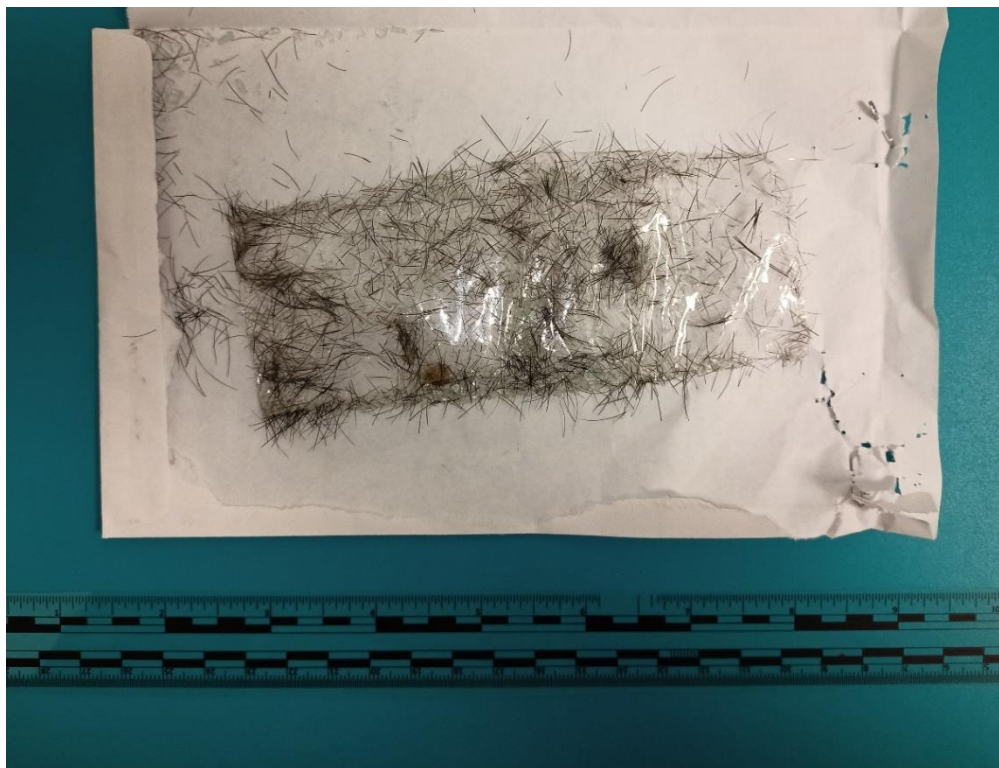

Figure 19.: Animal hair collected on the front of the car at the scene (evidence tag 67).

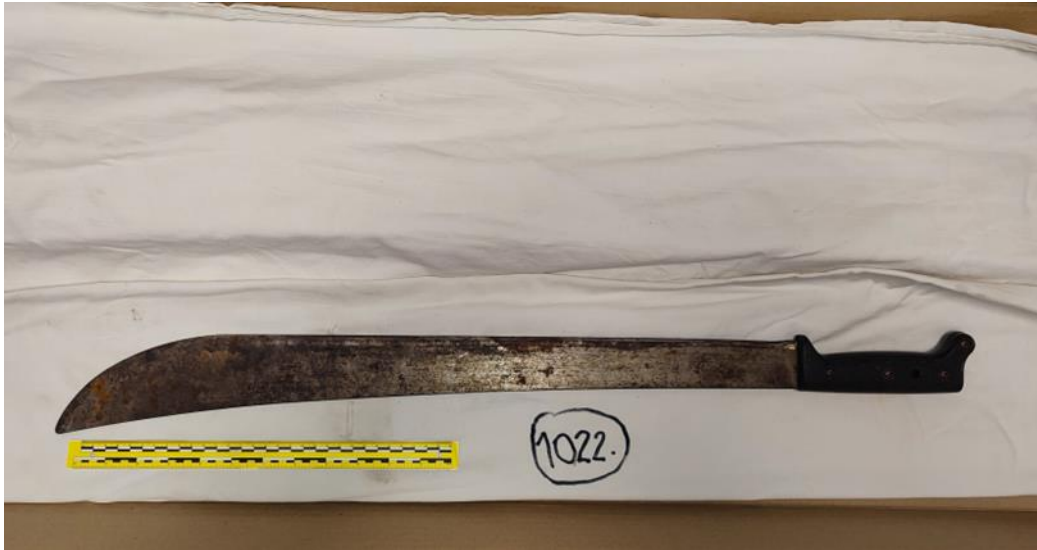

Figure 20.: A machete wrapped in a white sheet (evidence tag 1022).

### **Morphological characteristics of hair samples**

The hairs, each wrapped in their own paper casing, underwent spectrum analysis, and were examined using a stereo and light microscope. Later, it was determined that both tracks are hairs that come from animals. Upon examining evidence tag 62, it was noted that there were more than one hundred hairs with lengths varying from 1.3 to 2.2 cm. It was discovered that over 90% of these hairs were undamaged and, apart from the upper and middle portions, had hair follicles. The diameter of the hair varies throughout different areas. More precisely, it has a measurement of around 35  $\mu\text{m}$  at the point where the medulla starts changing into the apical region. The diameter of the hair ranges from 55 to 78  $\mu\text{m}$  at its center. Ultimately, at the lowermost section where the medulla concludes and changes into the root, the width measures around 65  $\mu\text{m}$ .

The hairs presented display a dark brown color, which aligns with the hair color commonly linked to dark gold in horses. An analysis was conducted to determine the distinct physical characteristics of the hair that are specific to the domestic horse (*Equus caballus* L.). The medulla, located at the center of the hair, is primarily identified by its consistent structure, displaying a prominent lattice pattern that covers around 60% of the hair's whole width. The cuticle, the outermost covering of the hair, consists of translucent scales. The scales can be classified as

overlapping without any protrusions, according to the fundamental categorization. The scales display a transverse arrangement determined by their positioning and alignment in relation to the longitudinal axis. The pieces exhibit smooth and streamlined shapes and are positioned at regular to wide intervals. The scales display a sinuous pattern defined by irregular undulations, corresponding to the specific type of patterns. The hair root displays a bulbous and tapering shape.

The second sample, identified as evidence tag 67, comprised a printed representation of a biological trace discovered at the site of a broken windshield. This sample contained several shards of glass and strands of hair. The majority of hairs, comprising more than 95%, have an imperfect structure, which is defined by the partial existence of the middle and higher sections. The hair length varies between 0.5 and 2.1 cm (about 0.83 inches). The term "diameter" refers to the straight-line segment that runs through the center of the upper region, precisely at the boundary between the visible section of the pith and the top portion. In this case, the hair measures around 55  $\mu\text{m}$ . The hair's central part has a range of 95-105  $\mu\text{m}$ . In the lower region, namely at the point where the visible part of the pith meets the base part-root, the hair has a length of around 65  $\mu\text{m}$ . By doing a thorough examination of the trace, we carefully separated all hair strands that included the hair root, aiming to obtain the best possible sample for extracting DNA and performing the planned molecular tests. Furthermore, apart from coding, there are also correspondences in morphological characteristics.

Figure 21.: The morpho-metric features of the hairs collected from the suspected mare, evidence tag 62, a) multiple hairs, b) middle part of the hair with visible pith, c) tip of the hair, d) root of the hair, e) broken part of the hair and f) surface of the hair.

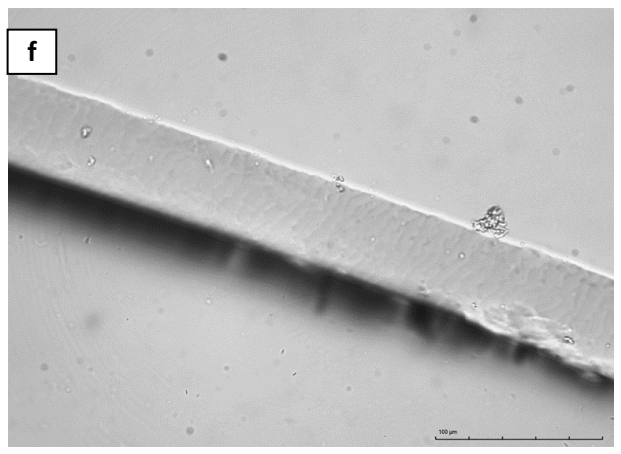
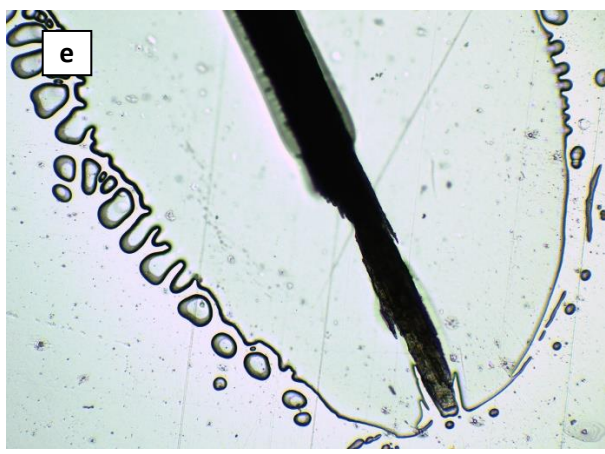
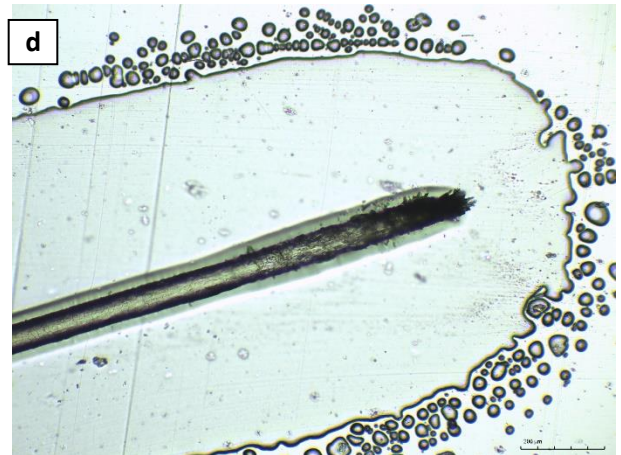
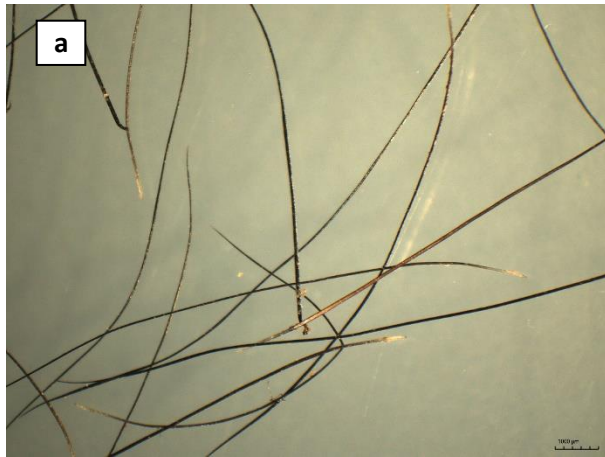
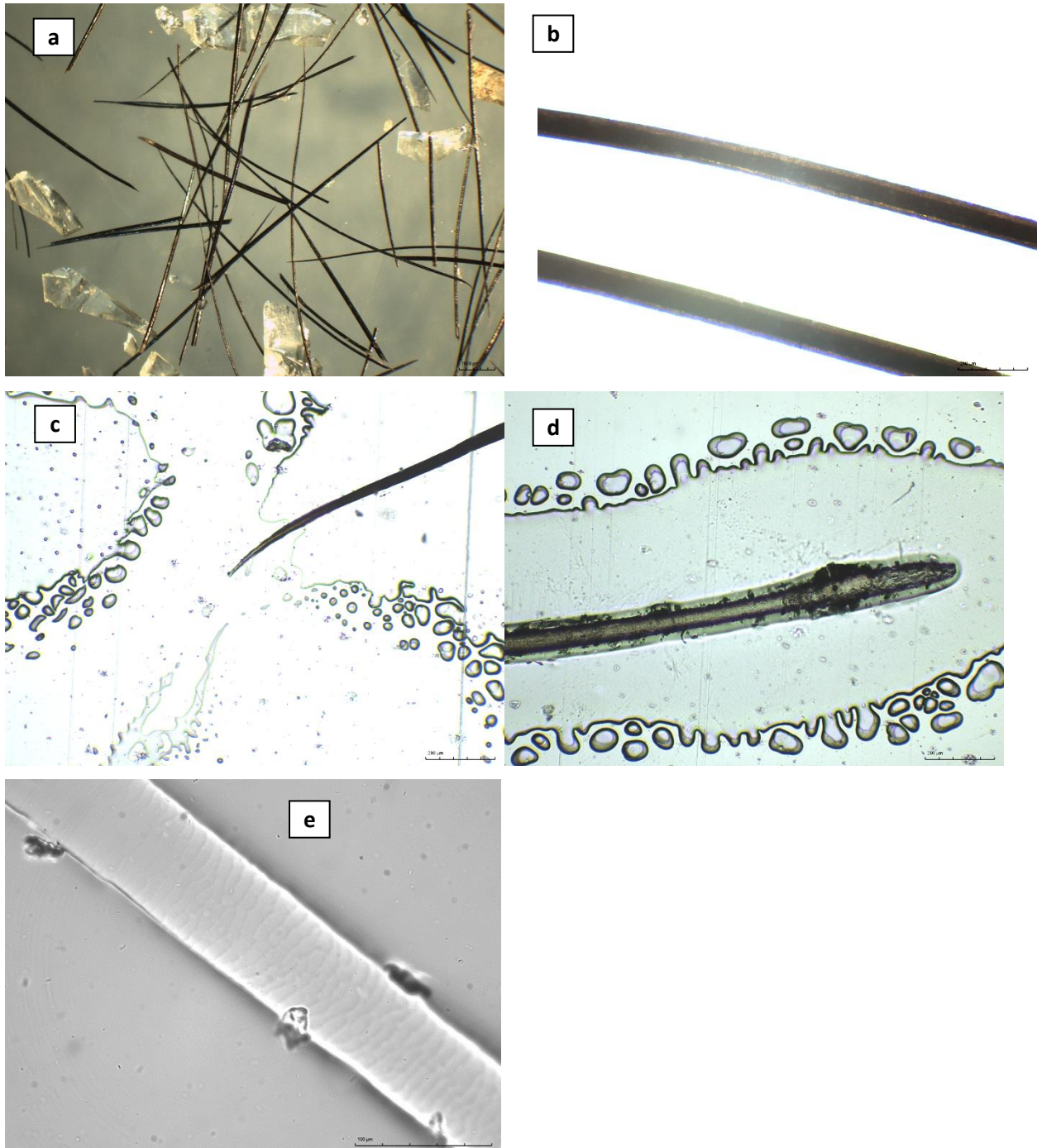



Figure 22.: The morpho-metric features of the hairs collected from the car, evidence tag 67, a) multiple hairs with pieces of glass, b) middle part of the hair with visible pith, c) tip of the hair, d) root of the hair and e) surface of the hair.



The machete, labeled as evidence tag 1022, underwent a thorough examination using a magnifying glass. Afterwards, a swab was taken from the surface of both sides of the sharp edge using a sterile stick moistened with sterile water. Once the samples were collected from the machete's surfaces, a luminol solution (Bluestar® Forensic) was applied to both sides of the object to aid in the identification of possible biological traces, particularly blood. However, no such traces were observed on any part of the machete.

### **Molecular identification of the biological evidence**

The DNA from all three traces was extracted using the QIAamp DNA Investigator Kit (Qiagen), following the instructions. The protocol outlined in the QIAamp DNA Investigator Handbook for hair DNA isolation was followed.

#### ***Determination of species-specific polymorphisms on the cytochrome b (CYT b) gene***

The species origin of the samples was identified by determining species-specific polymorphisms on the cytochrome b gene (CYT b) present in the mitochondrial DNA. Oligonucleotide primers specific for the CYT b gene were used: L14841 F: 5'-AAAAGCTTCCATCCAACATCTCAGCATGATGAAA-3' and H15149 R: 5'-AAAAGCTTCCATCCAACATCTCAGCATGATGAAA-3'. Oligonucleotide primers are being amplified by the QIAGEN® Multiplex kit (Qiagen, Hilden, Germany). The PCR reaction was prepared in accordance with the instructions provided by the manufacturer. The polymorphism, specific for each animal species, was determined by the method of determining the nucleotide sequence on the device ABI3730XL DNA Analyzer in the external DNA sequencing service (Macrogen Europe, Netherlands).

The PCR product sequences from the samples compare with the sequences in the NCBI database and conducted a phylogenetic analysis using the BLAST tool on the NCBI database.

#### ***Individual identification using short tandem repeat (STR) loci***

The identification of DNA in the sample of isolates from the submitted samples was determined by multiplying short tandem repeats (Str) by polymerase chain reaction (PCR). The

Equine Genotypes Panel 1.1 kit (Thermo Fisher Scientific Baltics UAB) was used, which contains 17 oligonucleotide primers for amplification of 17 equine STR loci: VHL20, HTG4, AHT4, HMS7, HTG6, AHT5, HMS6, ASB23, ASB2, HTG10, HTG7, HMS3, HMS2, ASB17, LEX3, HMS1 and CA425. The International Society for Animal Genetics recommends the use of these markers to determine the origin of ungulates. The kit used enables simultaneous amplification of all 17 STR loci. The PCR reaction was prepared according to the manufacturer's instructions (User Guide: Thermo Scientific Equine Genotypes Panel 1.1). PCR products were analyzed on a SeqStudio Genetic Analyzer (Applied Biosystems). Fragment analysis data (.fsa) files obtained after processing with an ABI PRISM® 310 Genetic Analyzer (Applied Biosystems) were analyzed in the GeneScan™ computer program.

Table 2.: Result of BLAST alignment correspondence.

<b>Evidence</b>	<b>Primer</b>	<b>BLAST alignment correspondence</b>	<b>Accession code</b>	<b>Identity percentage</b>
Hairs collected from the suspected mare; evidence tag 62	L14841	Equus caballus clone x14 cytochrome b (Cytb) gene	JQ282759.1	<b>90 %</b>
	H15149	Equus caballus mitochondrial Cytb gene for cytochrome b	LC088145.1	<b>100 %</b>
Hairs collected from the car; evidence tag 67	L14841	Equus caballus isolate MAC15 cytochrome b gene	MH594488.1	<b>97,25 %</b>
	H15149	Equus caballus mitochondrial Cytb gene for cytochrome b	LC088145.1	<b>99.35 %</b>
Biological traces from the machete; evidence tag 1022	L14841	no identity match		
	H15149	no identity match		

Table 4.: Result of allelic distribution on the 17 equine STR loci

STR loci	Evidence		
	Hairs collected from the suspected mare; evidence tag 62	Hairs collected from the car; evidence tag 67	Biological traces from the machete; evidence tag 1022
<b>VHL20</b>	P P	P P	--
<b>HTG4</b>	O O	O O	--
<b>AHT4</b>	J J	J J	--
<b>HMS7</b>	L N	L N	--
<b>HTG6</b>	O O	O O	--
<b>AHTS</b>	O O	O O	--
<b>HM6</b>	K M	K M	--
<b>ABS23</b>	K S	K S	--
<b>ASB2</b>	M M	M M	--
<b>HTG10</b>	O R	O R	--
<b>HTG7</b>	N N	N N	--
<b>HMS3</b>	Q Q	Q Q	--
<b>HMS2</b>	H K	H K	--
<b>ASB17</b>	N P	N P	--
<b>LEX3</b>	N P	N P	--
<b>HMS1</b>	J K	J K	--
<b>CA425</b>	J O	J O	--



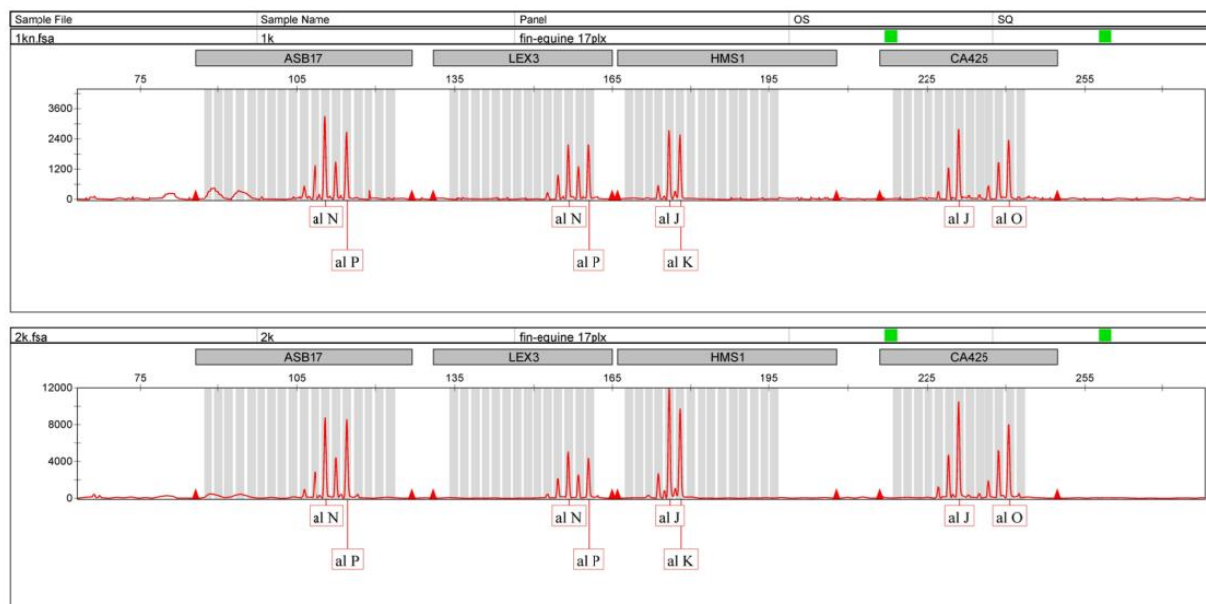

Figure 14.: Genotyper™ software analysis of PCR amplification products separated on the Applied Biosystems® 310 Genetic Analyzer. Comparison of results at STR loci: ASB17, LEX3, HMS1 and CA425.

### Expert witness opinion

The expertise is indisputable, as it has been demonstrated that the material evidence provided consists of trace samples marked 62 (hair sample from the suspected mare) and 67 (traces of animal hair found on the front part of the car), both of which are of biological origin. In both cases, the hairs possess morphological characteristics that correspond to those of the domestic horse (*Equus caballus* L.). Similarly, by a molecular examination of the DNA extracted from the hair samples, we identified species-specific variations on the cytochrome b gene (CYT b). These variations showed a strong similarity to the nucleotide sequences of the domestic horse (*Equus caballus* L.). The amplified DNA sequence obtained from the tag 1022 sample did not exhibit any notable similarity to any known nucleotide sequence of the Cyt B gene. Through the process of genotyping ungulates, a distinct DNA profile is created by amplifying a specific set of short tandem repeats that are important for the species using polymerase chain reaction. By comparing the STR profile at all 17 locations, it has been undeniably established that the DNA samples from mark 67 and 62

are an exact match. Therefore, we can confidently conclude that the animal hair found on the front part of the car belongs to the suspected mares.

#### **4. DISCUSSION**

Genetic evidence from domestic animals is a valuable forensic tool used for the identification and individualization of suspects in cases involving animal assaults and property damage. Applications have also encompassed civil and criminal forensic investigations pertaining to animal theft and mistreatment, as well as cases involving food poisoning and fraud. Genetic testing of biological elements from domestic animals has been employed to establish links between victims, perpetrators, and/or crime scenes (KANTHASWAMY, 2015).

The utilization of hair in forensic medicine is highly advantageous and contributes to various veterinary disciplines, including forensic investigations, clinical studies, wildlife surveillance, and more (VAN DE GOOR et al., 2011). The hair possesses distinctive characteristics that make it significant, mostly due to its resilient keratin composition, which remains unaffected by chemical and environmental alterations that would impact other forms of biological evidence (TÓTH et al., 2017). Accurate identification of hair is essential in the field of veterinary forensic medicine, as it offers useful insights into diverse instances of animal abuse and investigations into crimes involving wildlife or domesticated animals. By utilizing morphological and molecular techniques, we can differentiate between separate species by analyzing various physical traits as described by specialists. Additionally, we can accurately discern between individuals and establish their presence at a crime scene.

This case report demonstrates the utilization of both morphological and molecular approaches. At the crime site, biological evidence was gathered and dispatched to an expert for assessment to determine the species and individual in question. Two equines collided with a moving vehicle on the road, resulting in damage to the car. Subsequently, the horses fled the scene prior to the arrival of the investigative team. The hair discovered in various sections of the scene of the traffic accident has been gathered under aseptic conditions, which are crucial for the process. The hair samples were initially assessed based on their morphological traits, and subsequently subjected to DNA analysis in order to determine the precise identity of the individual. The horses' owner observed injuries on the horses, including a mare with a substantial open wound located behind the front left leg at the point where it connects to the chest. The skin tear measured approximately thirty centimeters in length, forming a u-shaped pattern, with a protruding piece of

adipose tissue. Additionally, the mare's foal had a wound on the inner side of its front right leg, located near the hoof, which was solely cleansed. The injuries were attended to by a veterinarian who was unable to determine the cause of the injuries. The owner of the horses in question asserted that the neighbor discovered a machete near the residence, leading her to presume that the machete was responsible for the injuries.

Following a thorough morphological analysis conducted by an expert, it was determined that the hair discovered at the scene of the traffic accident (evidence tags 62 and 67) was from an equine source. However, there was no discernible connection between the machete (evidence tag 1022) and equine hair. Following the negative outcome of the morphological examination of the machete, a DNA analysis was conducted by an expert using only the evidence collected from the scene of the traffic accident, namely evidence tags 62 and 67 (excluding evidence tag 1022-machete). The DNA of the owner's horses, specifically the mare and the foal, has been proven to be connected. Based on this information, we may conclude that the animals struck by the car were indeed horses, and there was no trace of horsehair found on the machete. Furthermore, based on the DNA study, we can definitively determine that the hair discovered at the scene of the traffic accident matches the DNA of the horse owned by the suspects. Consequently, we can confidently assert that the suspects were present at the scene of the traffic accident and had contact with the vehicle.

This case study highlights the significance of biological evidence, particularly the use of hair, in the field of forensics, particularly in relation to the increasing number of forensic investigations involving horses. The morphological and molecular approaches employed in the case report have demonstrated their effectiveness and their valuable contribution to the legal aspects of forensic inquiry. Furthermore, it is crucial to acknowledge that there exist numerous alternative approaches for utilizing biological evidence that can significantly contribute to the inquiry.

Given the rising prevalence of illicit practices in the veterinary field (CHEN et al., 2010), it is evident that enhancing these techniques will effectively reduce such unlawful activities and significantly aid in uncovering the truth during forensic investigations.

## 5. CONCLUSIONS

The significance of veterinary forensic medicine is evident in light of the escalating prevalence of illicit veterinary practices and the growing utilization of various animals for competitions, wildlife animals, research purposes, and other activities. More precisely, we observe an increase in the equestrian domain, where the application of diverse techniques might enhance our comprehension of legal matters, such as doping and parentage testing.

The structure of hair remains unchanged after death or exposure to environmental factors, making it a valuable source of biological evidence. This unique characteristic allows us to extract a wealth of information from hair, including details about various species, individuals, as well as their dietary and chemical information.

The utilization of Morphological and Molecular techniques for hair identification in horses holds great significance, and refining these techniques will prove invaluable in future legal proceedings, enabling us to expose the truth in such cases. The hair possesses distinctive morphological features, such as the cuticle and medulla (with the cortex being less significant), which play a crucial role in differentiating between various species. The molecular techniques, by analyzing the DNA extracted from hair, we may differentiate between individual animals. This is achieved using PCR technology and electrophoresis, which have shown advancements in improving the accuracy of these approaches while requiring less physical proof. In order to ensure accurate results, it is imperative to collect the evidence with maximum sensitivity, as any contamination might significantly interfere with the findings. It is essential that these processes are carried out by a qualified specialist.

The techniques were employed in a court proceeding pertaining to a pair of equines, specifically a female horse and her offspring, who recklessly ventured onto a thoroughfare and subsequently collided with a car. In order to determine the species of the animals involved in the collision, we conducted a morphological analysis of the hair. Based on this research, we concluded that the hair samples matched those of a horse. To identify the specific individuals, we employed molecular techniques that enabled us to identify the individuals and link the horses to the scene of the traffic accident.

This thesis demonstrates the significance and application of hair identification methods in a practical scenario, illustrating how this information might aid in uncovering the truth. These approaches will experience a rise in utilization in the future, therefore it is imperative that we continue to enhance and develop these ways to get superior outcomes.

## 6. REFERENCES

1. AHMED, Y.A., S. ALI, A. GHALLAB (2018): Hair histology as a tool for forensic identification of some domestic animal species. *EXCLI Journal: Experimental and Clinical Sciences*, 17, 663-670. DOI: <http://dx.doi.org/10.17179/excli2018-1478>
2. ALIBARDI, L. (2012): Immunolocalization of keratin-associated beta-proteins(beta-keratins) in the regenerating lizard epidermis indicates a new process for the differentiation of the epidermis in lepidosaurians. *J. Morph.* 273, 1271-1279. DOI: <https://doi.org/10.1002/jmor.20057>.
3. BAILEY, D. (2016): *Practical Veterinary Forensics*, First Edition. CABI. OXFORDSHIRE, UK, pp. 1-10.
4. BUCKLETON J.S, J.A. BRIGHT, and D. TAYLOR (2016): *Forensic DNA Evidence Interpretation*, Second Edition. CRC Press., 3-13.
5. BUILES, J., J. CASTRO, C. Velilla, L. BASTIDAS, C. AFANADOR, A. MANRIQUE, D. AGUIRRE, L. MENDOZA, M. BRAVO (2013): A new 15 autosomal STRs multiplex for domestic horse genotyping. *For. Sci. Inter. Gen. Supp. Ser.* 4, e95-e96. DOI: <https://doi.org/10.1016/j.fsigss.2013.10.049>.
6. BLAZEJ, A., A. GLATÍK, J. GALATÍK, Z. KRUL, and M. MLÁDEK (1989): *Atlas of microscopic structures of fur skins 1*. Elsevier Science Publishers B. V., New York, Aamsterdam.
7. BRUNNER H., B.J. COMAN (1974): *The identification of mammalian hair*. Melbourne: Inkata Press.
8. COLLABORATOR A, A. COLLABORATOR (2023): *Understanding Hair Growth Stages*. Capillus. URL <https://www.capillus.com/blogs/all/understanding-hair-growth-stages>.
9. CHEN J.W., C.E. UBOH, L.R. SOMA (2010): Identification of racehorse and sample contamination by novel 24-plex STR system. *For. Sci. Inter. Gen.* 4, 158–67. DOI: <https://doi.org/10.1016/j.fsign.2009.08.001>.
10. DE MARINIS, A. M., A. ASPREA (2006): Hair identification key of wild and domestic ungulates from southern Europe. *Wildlif. Biol.* 12, 305–320. DOI: [http://dx.doi.org/10.2981/0909-6396\(2006\)12\[305:hikowa\]2.0.co;2](http://dx.doi.org/10.2981/0909-6396(2006)12[305:hikowa]2.0.co;2).

11. FARAG, M. R. (2018): Forensic Identification of some Wild Animal Hair using Light and Scanning Electron Microscopy. *Adv. Anim. and Veterinary Sci.* 3(10), 559–568. DOI: <https://doi.org/10.14737/journal.aavs/2015/3.10.559.568>.
12. HICKS, J.W. (1977): Microscopy of hairs. Federal Bureau of investigation, FBI Laboratory, Washington, D.C. pp. 1-28.
13. KANTHASWAMY, S. (2015): Review: domestic animal forensic genetics – biological evidence, genetic markers, analytical approaches and challenges. *Anim. Gen.* 46, 473–484. DOI: <https://doi.org/10.1111/age.12335>.
14. MECKLENBURG, L., M. LINEK, D.J. TOBIN (2009): Hair Loss Disorders in Domestic Animals. John Wiley & sons. 3-16.
15. MADKOUR, F. A., M. ABDELSABOUR-KHSZLAF (2022): Performance scanning electron microscopic investigations and elemental analysis of hair of the different animal species for forensic identification. *Micros. Res. and Techniq.* 85, 2152–2161. DOI: <https://doi.org/10.1002/jemt.24073>.
16. PARRY, N. M., A. STOLL, (2020): The rise of veterinary forensics. *For. Sci. Inter.* 306, 110069. DOI: <https://doi.org/10.1016/j.forsciint.2019.110069>
18. PARAKKAL, P. F., N. J. ALEXANDER (1972): Keratinization. A survey of vertebrate epithelia. Academy Press, New York, London, 59pp.
19. RUDIN N., and K. INMAN (2001): An Introduction to Forensic DNA Analysis, Second Edition. CRC Press., 33-39.
20. SÁNCHEZ PEREZ, J. R., D. MOLINA PALACIOS, J. M. MARTÍNEZ GARRO (2022): Genetic Characterization of the Colombian Creole Horse Population Via Str Markers Used in Filiation Tests and Equine Certification. *SSRN Electr. Journ.* DOI: <https://doi.org/10.2139/ssrn.4214516>.
21. SARI A, and ARPACIK A (2018): MORPHOLOGICAL HAIR IDENTIFICATION KEY OF COMMON MAMMALS IN TURKEY. *Applied Ecology and Environmental Research*, 16(4): 4593–4603. DOI: [https://doi.org/10.15666/aeer/1604\\_45934603](https://doi.org/10.15666/aeer/1604_45934603).
22. TÒTH, M. (2017): Hair and Fur Atlas of Central European Mammals., 47-68. DOI: <https://doi.org/10.18655/hairatlas>.



23. THOMPSON, J. E. (2022): Matrix-assisted laser desorption ionization-time-of-flight mass spectrometry in veterinary medicine: Recent advances (2019–present). *Vet. World* 2623–2657. DOI: <https://doi.org/10.14202/vetworld.2022.2623-2657>
24. TOUROO, R., and A. FITCH, (2016): Identification, Collection, and Preservation of Veterinary Forensic Evidence. *Vet. Path.* 53, 880–887. DOI: <https://doi.org/10.1177/0300985816641175>.
25. TEERINK, B.J. (1991): *Hair of West European Mammals: Atlas and identification key*. Cambridge University Press, Cambridge, 233 pp.
26. VAN DE GOOR, L. H. P., W. A. VAN HAERINGEN, J. A. LENSTRA (2011): Population studies of 17 equine STR for forensic and phylogenetic analysis. *Anim. Gen.* 42, 627–633. DOI: <https://doi.org/10.1111/j.1365-2052.2011.02194.x>

## **7. ABSTRACT**

### **Identification of horses by hair as trace evidence - case study**

**David Lurie**

This thesis examines the practicality and dependability of utilizing equine hair as trace evidence for the purpose of identifying specific horses. Aims of thesis to comprehend the scientific principles underlying accurate forensic techniques in animal-related damages to the properties. Specifically, it focuses on the structure and development of hair, as well as the distinctive properties that enable the identification of various species. Furthermore, it explores the field of molecular identification by utilizing DNA extracts to precisely identify species at the individual level, employing specific STR markers. The investigation used a case study methodology to identify the species involved in a car accident, based on morphological characteristics and molecular techniques which helped finding the truth. This case study shows us the importance of having a good understanding of these methods to uncover the truth in legal cases and the advantages that it gives us for understanding what has happened.

**Keywords:** equine, hair, evidence

## **8. SAŽETAK**

### **Identifikacija konja temeljem dlake kao materijalnog traga – prikaz slučaja**

**David Lurie**

Diplomski rad obrađuje praktičnost i pouzdanost korištenja konjske dlake kao traga u svrhu vrsne ali i individualne identifikacije konja. Cilj diplomskog rada je razumijevanje znanstvenih principa na osnovu kojih se temelji pouzdanost forenzičkih tehnika s ciljem identifikacije počinitelja kod oštećenja imovine uzrokovanih životinjama. Konkretno, usmjeren je na spoznaje o strukturi i razvoju dlake, kao i na karakteristična svojstva koja omogućuju identifikaciju različitih vrsta. Nadalje, analizira područje molekularne identifikacije korištenjem DNK za preciznu identifikaciju vrsta na individualnoj razini, koristeći specifične STR markere. Na primjeru iz sudske prakse prikazana je istražni postupka u identifikaciji vrste i jedinke na temelju morfoloških karakteristika i molekularnih tehnika za koju je postavljena sumnja na sudjelovale u prometnoj nesreći. Analiza konkretnog slučaja pokazuje važnost dobrog razumijevanja primijenjenih metoda kako bi se utvrdila materijalna istina i prednosti koje nam daje kod utvrđivanja okolnosti događaja.

**Ključne riječi:** konj, dlaka, dokazi

## **9. CURRICULUM VITAE**

I am David Lurie, born in Israel, Tel-Aviv, where I spent my formative years. Completed my secondary schooling at Alliance High School in Tel-Aviv. In 2009, I was enlisted in the IDF and served till 2012. I have registered for the Faculty of Veterinary Medicine at the University of Zagreb.

Since the commencement of my Veterinary studies, I have been captivated by all facets of the veterinary field and actively sought opportunities to volunteer in diverse settings. I served as a volunteer at Noina Arka, a shelter dedicated to providing care for cats and dogs. Additionally, I have dedicated three years of my time to volunteering at the horse clinics held at the Veterinary Medicine University of Zagreb.

Furthermore, throughout our years of education, my colleagues and I established the Vet Society with the aim of facilitating the integration between the English and Croatian language sections. Thanks to this Organization, we successfully constructed a state-of-the-art anatomy facility for the students of the University, along with numerous other initiatives.

In the 2023 semester, I commenced collaborating on a project with Prof. K. Severin from the department of Forensic and State Veterinary Medicine Unit.